

Quick start TOP-V8/4

Control unit for until 4 single colour strip
(LEDs with constant voltage)

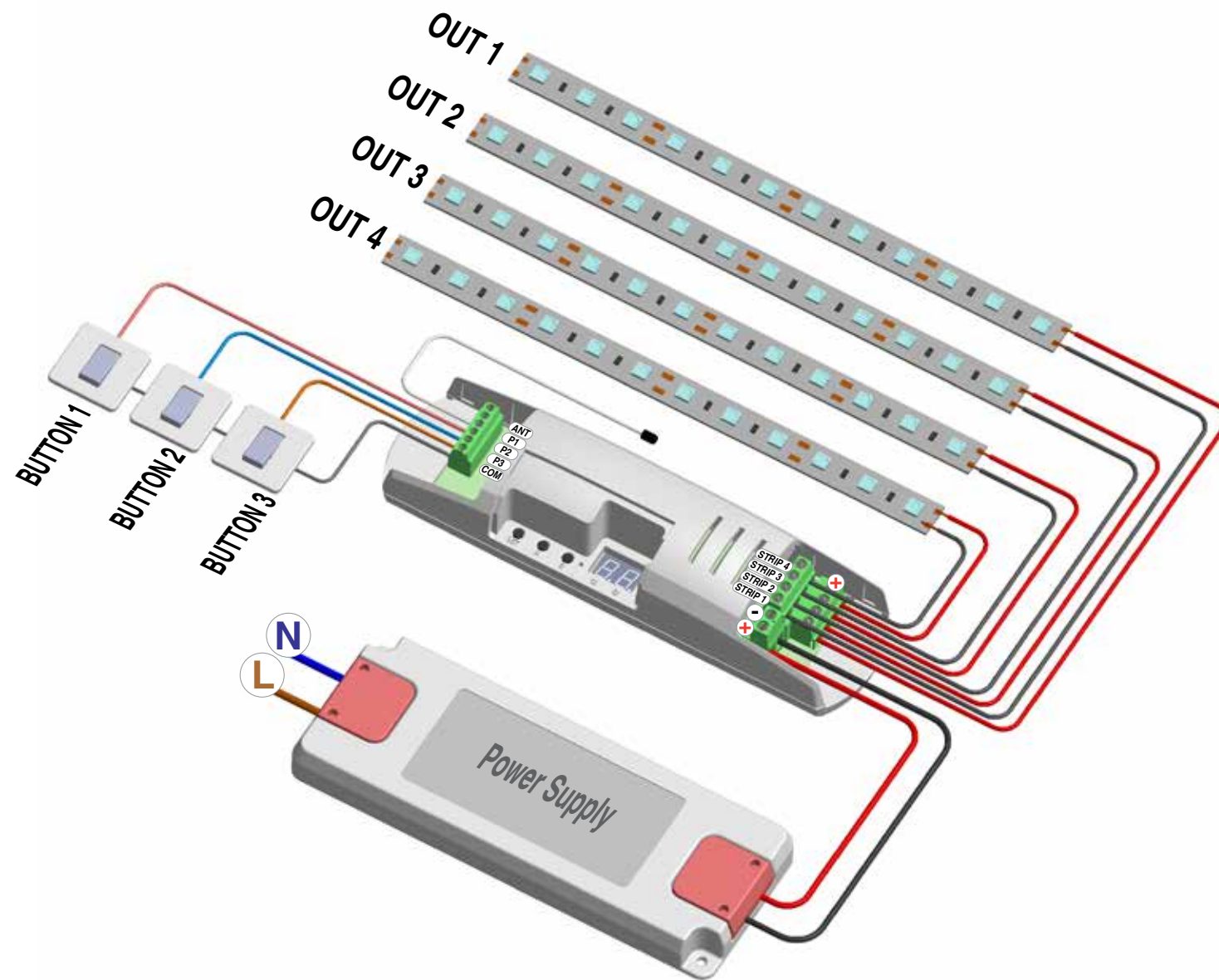

CONNECTION DIAGRAM



ATTENTION:

See the full manual for the restrictions on use and full features of the control unit

DESCRIPTION

Once the connections are made as in the drawing, the control unit is already operational via wire with the pre-set functions and default settings.

USE VIA WIRE

The function of the keys is pre-set.

Button 1:

short press= On Off strip 1

long press= dimmer up/down strip 1

Button 2:

short press= On Off strip 2

long press= dimmer up/down strip 2

Button 3:

short press= On Off strip 3

long press= dimmer up/down strip 3

NOTA: strip 4 can be controlled only by radio or if the inputs are set as synchronised

USE VIA RADIO

To be able to use a transmitter an association must first be made, see procedure on the back

DEFAULT PARAMETERS

The control unit has pre-set parameters for standard operation.

- synchronised loads: disabled
- memo function: disabled
- fade on: 0,5s
- fade off: 0,5s
- timer: none

These settings can be customised, see the full manual.

RADIO PROGRAMMING

This procedure lets you programme compatible multifunctional or generic transmitters.

WHICH REMOTE CONTROL DO YOU WANT TO ASSOCIATE WITH THE CONTROL UNIT?

MULTIFUNCTIONAL TRANSMITTERS - MODELS AND CODES

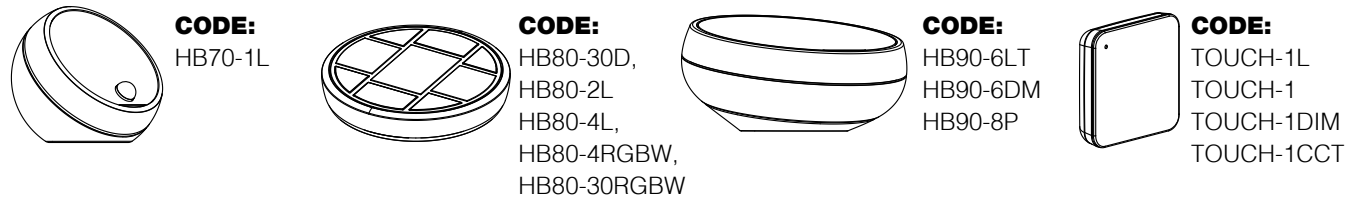

With multifunctional transmitters the transmitter control modes depend on the model used. Refer to the transmitter manual, to the paragraph entitled "commands sent by the transmitter", bearing in mind that it is a "dimmer" device.

GENERIC TRANSMITTERS - MODELS AND CODES



With generic transmitters, the transmitter's control modes depend on the function associated with the key during the association procedure. The available function for the key are:

TABELLA 4.1 - KEY FUNCTIONS OF THE GENERIC TRANSMITTER

NUMBER TO BE SET IN "STEP 4b" OF THE PROCEDURE	KEY FUNCTION
2	ON/OFF
3	ON
4	OFF
5	Dimmer intensità UP
6	Dimmer intensità DOWN
7	Short press: ON/OFF Prolonged press: Dimmer intensità UP/ DOWN
8	Short press: ON Prolonged press: Dimmer intensità UP
9	Short press: OFF Prolonged press: Dimmer intensità DOWN
0	"Soft Off 1 hr": gradual fading in one hour (see paragraph 5.1)

PROCEDURE

STEP 1

Short presses on the "SET" key let you scroll through the menu until "P1" programming appears on the display.

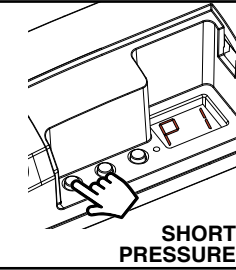

STEP 2

A prolonged press on the "SET" key (approx. 3 seconds) takes you into programming.

The LED on the receiver comes on

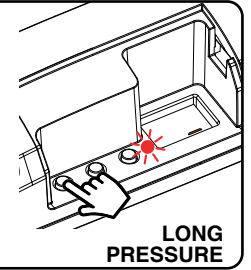

STEP 3

WHICH OUTPUT DO YOU WANT TO CONTROL?

Short presses on key "A" let you choose the output to programme the transmitter on, shown on display "a", see table alongside.

DISPLAY "a"	OUTPUT
1	OUT 1
2	OUT 2
3	OUT 3
4	OUT 4
A	ALL OUT

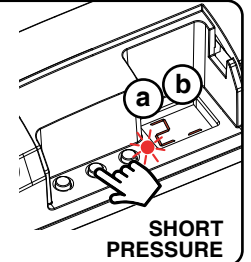

WHICH TRANSMITTER DO YOU WANT TO PROGRAMME?

MULTIFUNCTION TRANSMITTER
(see models and codes on previous page)

GENERIC TRANSMITTER
(see models and codes on previous page)

STEP 4a

Short presses on key "B" let you set value "1" on the display

(the display "a" shows the output to associate to the transmitter)

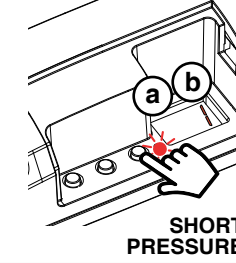

STEP 4b

Short presses on key "B" let you choose the function you want to programme shown on the displays. See table 4.1 on the previous page.

(the display "a" shows the output to associate to the transmitter)

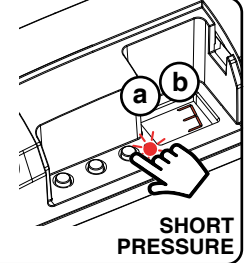

STEP 5

Give a long press on key "B" (approx. 3 seconds).

The LED on the display comes on

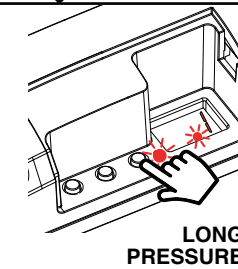

STEP 6

Make a transmission with the transmitter to be saved (see transmitter manual, the paragraph entitled "transmitter programming").

The LED on the receiver flashes 3 times to signal that it has been received.

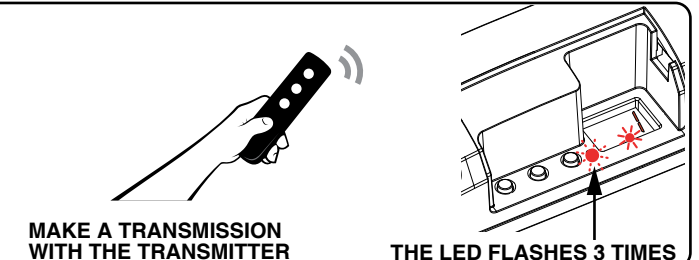

STEP 7

The control unit listens for 50 seconds in case you want to add other transmitters. To immediately exit the procedure give a short pressure on key "b".

The LED on the display turns off

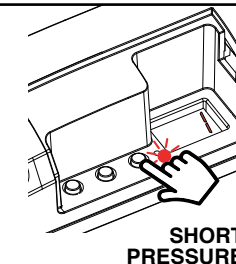

STEP 8

The control unit goes back to the menu displaying the radio programming. If you want to save other transmitters, go back to point 3 of this procedure.

If you want to go back to the menu displaying the different types of programming, give a prolonged press to the "SET" key (approx. 3 seconds).